

WESTGATE

MICROWAVE MOTION SENSOR USER'S MANUAL

Model:WEC-2MD-35

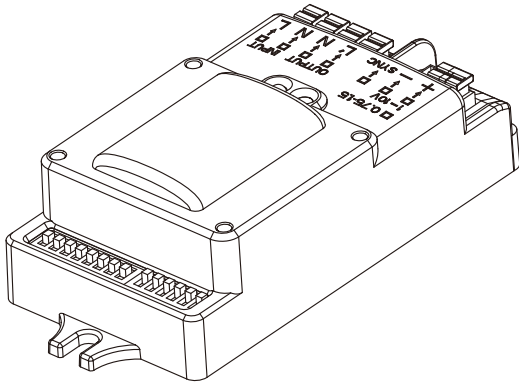

EN

Instruction
MI181023A0

UL E480996



FEATURE

- Automatic switching or dimming when used in combination with 1-10V dimmable LED drivers or ballasts.
- Built-in daylight sensor.
- 1-10V interface can match up with Merrytek stand-alone daylight sensor MS01 and achieve daylight harvesting.
- Compact size makes it suitable to fix within most luminaires.
- Detection area, time delay and daylight threshold can be precisely set via DIP switch.
- Wide detection area, range up to 16m in diameter.
- Support higher mounting height 12m Max.
- Optional surface mounting and base mounting

SPECIFICATIONS

Operating voltage	120~277Vac, 50Hz/60Hz
Rated capacitive load	400W@120V ;1000W@277V(Ballast) 800W@120V;1000W@277V(Resistive)
HF system	5.8GHz±75MHz, ISM wave band
Transmitting power	<0.5mW
Power consumption	≥0.5W(standby), <1W(operation)
Detection zone	Max.(D x H): 16m x 12m
Detection sensitivity	10% / 50% / 75% / 100%
Hold time	5s / 30s / 90s / 3min / 20min / +∞
Daylight sensor	2lux/5lux / 10lux / 25lux /50lux / 100lux / Disable
Stand-by period	0s /5s / 5min / 10min / 30min / 1h / +∞
Stand-by dimming level	10% / 20% / 30% / 50%
Mounting height	15m Max.
Motion detection	0.5~3m/s
Detection angle	150°(wall installation), 360°(ceiling installation)
Operating temperature	-35°C~70°C
IP rating	IP20

GENERAL GUIDELINES FOR INSTALLATION

- 1, The sensor should be installed by a qualified electrician. And ensure that the electricity supply is switched off before installing or servicing the product.
- 2, The sensor should not be modified in any way. Any modifications made for this product will immediately invalidate any warranties issued.
- 3, The company does not accept responsibility for any consequences resulting from unauthorized modification of the product.
- 4, The sensor should be connected to a stable power supply of 120-277Vac 50Hz/60Hz.
- 5, Microwaves cannot pass through metal or brick walls if thicker than 20cm. They will pass through thinner walls but there will be some attenuation.
- 6, Installation inside a glass or plastic housing will result in a reduction of detection sensitivity. Expect a reduction of approximately 20% for every 3mm of thickness.

INSTALLATION & WIRING

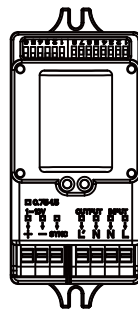

Pic 1

The sensor has 7-position terminal block as Pic 1:

L(Phase) N(Neutral) L (Switched phase / control)
1-10V (Connected to 1-10V interface) Sync
(synchronization)

The sensor is designed for installation at 3-12m in height.

WIRING SCHEME

1) FOR ON/OFF FUNCTION :

Connect to normal control gears (normal LED drivers or ballasts), the wiring as following:

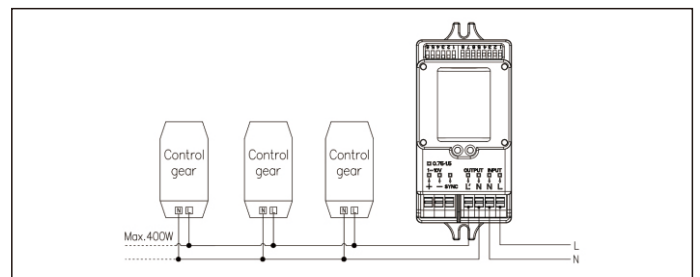

2) FOR DIMMING FUNCTION :

Connect to 1-10v dimmable control gears (1-10v LED drivers or ballasts), the wiring as following:

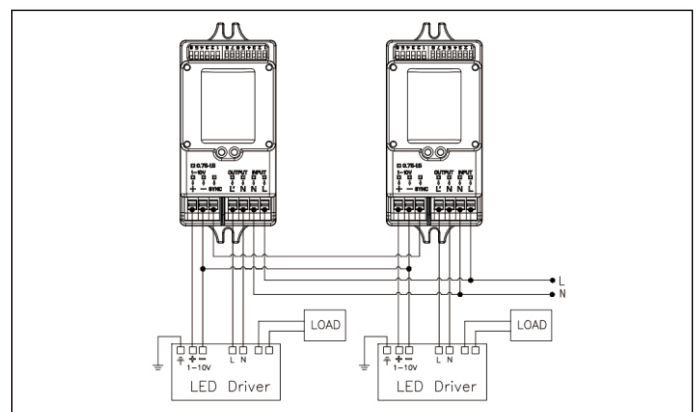

3) THE MOTION SENSOR CAN MATCH UP WITH MERRYTEK STAND-ALONE DAYLIGHT SENSORS TO ACHIEVE DAYLIGHT HARVESTING CONTROL .

Note: The daylight sensor level of the motion sensor should be set to Disable mode if connect to the daylight sensors.
The wiring is as following.

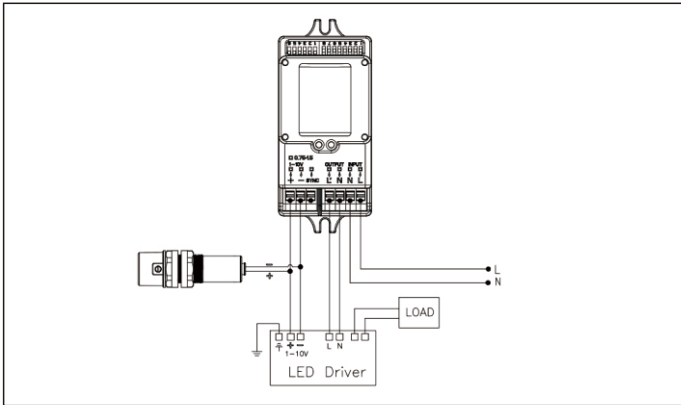

DETECTION PATTERN

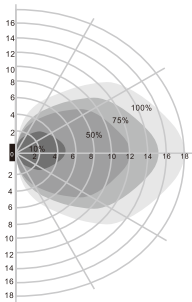

Wall mounting pattern (Unit: m)
Suggested installation height: 1-1.8m

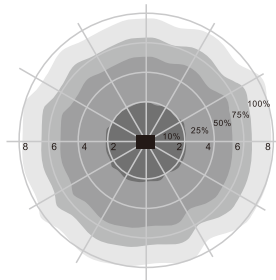

Ceiling mounting pattern (Unit: m)
Suggested installation height: 3-12m

4,Daylight sensor

The sensor can be set to only allow the lamp to illuminate below a defined ambient brightness threshold. The settings are as follows:

- I: 2lux, darkness operation only
- II: 5lux, darkness operation only
- III: 10lux, twilight operation
- IV: 25lux, twilight operation
- V: 50lux, twilight operation
- VI: 100lux, twilight operation
- VII: Disable

*When set to Disable, the daylight sensor will switch on the lamp when motion is detected regardless of ambient light levels.
*It should be set to Disable mode if the motion sensor is connected to stand-alone daylight sensors.

	1	2	3	4	
I	-	-	ON	ON	2Lux
II	-	-	-	ON	5Lux
III	-	ON	ON	-	10Lux
IV	-	-	ON	-	25Lux
V	-	ON	-	-	50Lux
VI	ON	-	-	-	100Lux
VII	-	-	-	-	Disable

5,Stand-by dimming level

This is the pre-setting dimming level you would like to have after the hold time in the long absence of people.

- I: 50%
- II: 30%
- III: 20%
- IV: 10%

	5	6	
I	ON	ON	50%
II	-	ON	30%
III	ON	-	20%
IV	-	-	10%

SETTINGS

Detection area, hold time and daylight sensor can be set by using DIP switches on the sensor. Note that reducing the detection area will also reduce the sensitivity.

1, Detection area

- I: up to 100%
- II: up to 75%
- III: up to 50%
- IV: up to 10%

	1	2	
I	ON	ON	100%
II	ON	-	75%
III	-	ON	50%
IV	-	-	10%

2, Hold time

Refers to the time period the lamp remains at 100% illumination after no motion is detected.

- I: 5s
- II: 30s
- III: 90s
- IV: 3min
- V: 20min
- VI: +∞

	3	4	5	
I	ON	ON	ON	5S
II	-	ON	ON	30S
III	ON	-	ON	90S
IV	-	-	ON	3min
V	ON	ON	-	20min
VI	-	-	-	+∞

When set to +∞,The sensor function will be inactive, the light will go back to normal one.

3, Stand-by period

Refers to the time period the lamp remains at a pre-setting dimming level before it completely switches off in the long absence of people.

- I: 0s
- II: 5s
- III: 5min
- IV: 10min
- V: 30min
- VI: 1H
- VII: +∞

	6	7	8	
I	ON	ON	ON	0S
II	-	ON	ON	5S
III	ON	-	ON	5min
IV	-	-	ON	10min
V	ON	ON	-	30min
VI	-	ON	-	1h
VII	-	-	-	+∞

* when set to 0s, the lamp will work as on/off function

* When set both daylight sensor and stand-by period to Disable.

the lamp will work as 2-step dimming control (Motion detected, 100%lm, no motion, remains at pre-setting level lumens)

FAQ

Question	Cause	Remedy
The load will not illuminate	Incorrect daylight sensor setting selected.	Adjust setting.
	Load has failed.	Replace load.
	Power is switched off.	Switch on.
The load is permanently illuminated.	Continuous movement in the detection area.	Check detection area setting.
	The lamp (containing sensor) is installed in an area too close to reflective surfaces, i.e. metal, glass or concrete walls.	1, Make sure installation area suitable with at least 30cm space between lamp and surrounding reflective surfaces. 2, Reduce sensitivity (detection area).
The load will not illuminate despite movement.	Speed of moving object is not in the range of 0.5-3m/s or the detection radius is too small.	Check detection area setting.